

FEATURES

- Gain Bandwidth Product, $A_V = 5$: 350MHz
- Slew Rate: 450V/ μ s
- Low Cost
- Output Current: ± 50 mA
- Settling Time: 90ns to 0.1%
- Differential Gain Error: 0.1% ($R_L = 1$ k)
- Differential Phase Error: 0.01° ($R_L = 1$ k)
- High Open-Loop Gain: 100V/mV Min
- Single Supply 5V Operation
- Output Shutdown

APPLICATIONS

- Video Cable Drivers
- Video Signal Processing
- Photo Diode Amplifier
- Pulse Amplifiers
- D/A Current to Voltage Conversion

DESCRIPTION

The LT1192 is a video operational amplifier optimized for operation on ± 5 V and a single 5V supply. Unlike many high speed amplifiers, this amplifier features high open-loop gain, over 100dB, and the ability to drive heavy loads to a full-power bandwidth of 20MHz at 7V_{P-P}. In addition to its very fast slew rate, the LT1192 has a high gain bandwidth of 350MHz and is compensated for a closed-loop gain of 5 or greater.

Because the LT1192 is a true operational amplifier, it is an ideal choice for wideband signal conditioning, active filters, and applications requiring speed, accuracy and low cost.

The LT1192 is available in 8-pin PDIP and SO packages with standard pinouts. The normally unused Pin 5 is used for a shutdown feature that shuts off the output and reduces power dissipation to a mere 15mW.

LT, LTC and LT are registered trademarks of Linear Technology Corporation.

TYPICAL APPLICATION

Double Terminated Cable Driver

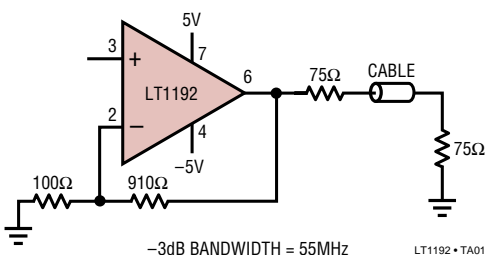

Inverter Pulse Response

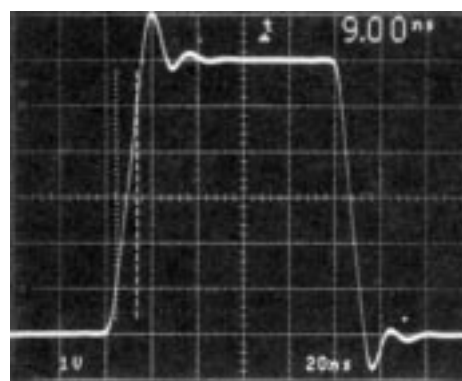

$A_V = -5$, $C_L = 10$ pF SCOPE PROBE

ABSOLUTE MAXIMUM RATINGS

(Note 1)

Total Supply Voltage (V^+ to V^-)	18V
Differential Input Voltage	$\pm 6V$
Input Voltage	$\pm V_S$
Output Short-Circuit Duration (Note 2)	Continuous
Operating Temperature Range	
LT1192M (OBSOLETE)	-55°C to 125°C
LT1192C	0°C to 70°C
Maximum Junction Temperature	150°C
Storage Temperature Range	-65°C to 150°C
Lead Temperature (Soldering, 10 sec)	300°C

PACKAGE DESCRIPTION

TOP VIEW

N8 PACKAGE
8-LEAD PDIP

S8 PACKAGE
8-LEAD PLASTIC SO

J8 PACKAGE 8-LEAD CERDIP
 $T_{JMAX} = 150^\circ\text{C}$, $\theta_{JA} = 100^\circ\text{C/W}$ (N8)
 $T_{JMAX} = 150^\circ\text{C}$, $\theta_{JA} = 150^\circ\text{C/W}$ (S8)

OBSOLETE PACKAGE
Consider the N8 or S8 Packages for Alternate Source

ORDER PART NUMBER

LT1192CN8
LT1192CS8

S8 PART MARKING

1192

LT1192MJ8
LT1192CJ8

Consult LTC Marketing for parts specified with wider operating temperature ranges.

ELECTRICAL CHARACTERISTICS

$V_S = \pm 5V$, $T_A = 25^\circ\text{C}$, $C_L \leq 10\text{pF}$, Pin 5 open circuit unless otherwise noted.

SYMBOL	PARAMETER	CONDITIONS	LT1192M/C			UNITS
			MIN	TYP	MAX	
V_{OS}	Input Offset Voltage	N8 Package SO-8 Package		0.2	2.5 3	mV mV
I_{OS}	Input Offset Current			0.2	1.7	μA
I_B	Input Bias Current			± 0.5	± 2.5	μA
e_n	Input Noise Voltage	$f_0 = 10\text{kHz}$		9		$\text{nV}/\sqrt{\text{Hz}}$
i_n	Input Noise Current	$f_0 = 10\text{kHz}$		4		$\text{pA}/\sqrt{\text{Hz}}$
R_{IN}	Input Resistance	Differential Mode		16		$\text{k}\Omega$
		Common Mode		5		$\text{M}\Omega$
C_{IN}	Input Capacitance	$A_V = 10$		1.8		pF
	Input Voltage Range	(Note 3)	-2.5		3.5	V
CMRR	Common Mode Rejection Ratio	$V_{CM} = -2.5V$ to $3.5V$	70	85		dB
PSRR	Power Supply Rejection Ratio	$V_S = \pm 2.375V$ to $\pm 8V$	70	85		dB
A_{VOL}	Large-Signal Voltage Gain	$R_L = 1\text{k}$, $V_O = \pm 3V$	100	180		V/mV
		$R_L = 100\Omega$, $V_O = \pm 3V$	16	35		V/mV
		$V_S = \pm 8V$, $R_L = 100\Omega$, $V_O = \pm 5V$	20	60		V/mV
V_{OUT}	Output Voltage Swing	$V_S = \pm 5V$, $R_L = 1\text{k}$	± 3.7	± 4		V
		$V_S = \pm 8V$, $R_L = 1\text{k}$	± 6.7	± 7		V
SR	Slew Rate	$A_V = -10$, $R_L = 1\text{k}$ (Notes 4, 9)	325	450		$\text{V}/\mu\text{s}$
FPBW	Full-Power Bandwidth	$V_O = 6V_{P-P}$ (Note 5)	17.2	23.9		MHz
GBW	Gain Bandwidth Product			350		MHz
t_{r1} , t_{f1}	Rise Time, Fall Time	$A_V = 50$, $V_O = \pm 1.5V$, 20% to 80% (Note 9)	23	35	50	ns
t_{r2} , t_{f2}	Rise Time, Fall Time	$A_V = 5$, $V_O = \pm 125\text{mV}$, 10% to 90%		2.7		ns
t_{PD}	Propagation Delay	$A_V = 5$, $V_O = \pm 125\text{mV}$, 50% to 50%		3.5		ns
	Overshoot	$A_V = 5$, $V_O = \pm 125\text{mV}$		50		%
t_s	Settling Time	3V Step, 0.1% (Note 6)		90		ns

ELECTRICAL CHARACTERISTICS $V_S = \pm 5V$, $T_A = 25^\circ C$, $C_L \leq 10pF$, Pin 5 open circuit unless otherwise noted.

SYMBOL	PARAMETER	CONDITIONS	LT1192M/C			UNITS
			MIN	TYP	MAX	
Diff A_V	Differential Gain	$R_L = 150\Omega$, $A_V = 10$ (Note 7)		0.23		%
Diff Ph	Differential Phase	$R_L = 150\Omega$, $A_V = 10$ (Note 7)		0.15		Deg _{p-p}
I_S	Supply Current			32	38	mA
	Shutdown Supply Current	Pin 5 at V^-		1.3	2	mA
I_{SHDN}	Shutdown Pin Current	Pin 5 at V^-		20	50	μA
t_{ON}	Turn On Time	Pin 5 from V^- to Ground, $R_L = 1k$		100		ns
t_{OFF}	Turn Off Time	Pin 5 from Ground to V^- , $R_L = 1k$		400		ns

$V_S^+ = 5V$, $V_S^- = 0V$, $V_{CM} = 2.5V$, $T_A = 25^\circ C$, $C_L \leq 10pF$, Pin 5 open circuit unless otherwise noted.

SYMBOL	PARAMETER	CONDITIONS	LT1192M/C			UNITS
			MIN	TYP	MAX	
V_{OS}	Input Offset Voltage	All Packages		0.4	4	mV
I_{OS}	Input Offset Current			0.2	1.2	μA
I_B	Input Bias Current			± 0.5	± 1.5	μA
	Input Voltage Range	(Note 3)	2		3.5	V
CMRR	Common Mode Rejection Ratio	$V_{CM} = 2V$ to $3.5V$	60	80		dB
A_{VOL}	Large-Signal Voltage Gain	$R_L = 100\Omega$ to Ground, $V_O = 1V$ to $3V$	30	50		V/mV
V_{OUT}	Output Voltage Swing	$R_L = 100\Omega$ to Ground	V_{OUT} High	3.6	3.8	V
			V_{OUT} Low		0.25	0.4
SR	Slew Rate	$A_V = -5$, $V_O = 1V$ to $3V$		250		V/ μs
GBW	Gain Bandwidth Product			350		MHz
I_S	Supply Current			29	36	mA
	Shutdown Supply Current	Pin 5 at V^-		1.2	2	mA
I_{SHDN}	Shutdown Pin Current	Pin 5 at V^-		20	50	μA

The ● denotes the specifications which apply over the full operating temperature range of $-55^\circ C \leq T_A \leq 125^\circ C$.
 $V_S = \pm 5V$, Pin 5 open circuit unless otherwise noted.

SYMBOL	PARAMETER	CONDITIONS		LT1192M			UNITS
				MIN	TYP	MAX	
V_{OS}	Input Offset Voltage	N8 Package	●		0.4	3.5	mV
$\Delta V_{OS}/\Delta T$	Input V_{OS} Drift		●		2		$\mu V/^\circ C$
I_{OS}	Input Offset Current		●		0.2	2	μA
I_B	Input Bias Current		●		± 0.5	± 2.5	μA
				CMRR	Common Mode Rejection Ratio	$V_{CM} = -2.5V$ to $3.5V$	65
PSRR	Power Supply Rejection Ratio	$V_S = \pm 2.375V$ to $\pm 5V$	●	70	90	dB	
A_{VOL}	Large-Signal Voltage Gain	$R_L = 1k$, $V_O = \pm 3V$	●	55	90	V/mV	
		$R_L = 100\Omega$, $V_O = \pm 3V$	●	5	14	V/mV	
V_{OUT}	Output Voltage Swing	$R_L = 1k$	●	± 3.7	± 3.9	V	
I_S	Supply Current		●		32	38	mA
	Shutdown Supply Current	Pin 5 at V^- (Note 8)	●		1.5	2.5	mA
I_{SHDN}	Shutdown Pin Current	Pin 5 at V^-	●		20	μA	

ELECTRICAL CHARACTERISTICS The ● denotes the specifications which apply over the full operating temperature range of $0^{\circ}\text{C} \leq T_A \leq 70^{\circ}\text{C}$. $V_S = \pm 5\text{V}$, Pin 5 open circuit unless otherwise noted.

SYMBOL	PARAMETER	CONDITIONS	LT1191C			UNITS
			MIN	TYP	MAX	
V_{OS}	Input Offset Voltage	N8 Package	●	0.4	3	mV
		SO-8 Package			4	mV
$\Delta V_{OS}/\Delta T$	Input V_{OS} Drift		●	2		$\mu\text{V}/^{\circ}\text{C}$
I_{OS}	Input Offset Current		●	0.2	1.7	μA
I_B	Input Bias Current		●	± 0.5	± 2.5	μA
CMRR	Common Mode Rejection Ratio	$V_{CM} = -2.5\text{V to } 3.5\text{V}$	●	68	85	dB
PSRR	Power Supply Rejection Ratio	$V_S = \pm 2.375\text{V to } \pm 5\text{V}$	●	70	90	dB
A_{VOL}	Large-Signal Voltage Gain	$R_L = 1\text{k}, V_O = \pm 3\text{V}$	●	90	140	V/mV
		$R_L = 100\Omega, V_O = \pm 3\text{V}$	●	10	30	V/mV
V_{OUT}	Output Voltage Swing	$R_L = 1\text{k}$	●	± 3.7	± 3.9	V
I_S	Supply Current		●	32	38	mA
	Shutdown Supply Current	Pin 5 at V^- (Note 8)	●	1.4	2.1	mA
I_{SHDN}	Shutdown Pin Current	Pin 5 at V^-	●	20		μA

Note 1: Absolute Maximum Ratings are those values beyond which the life of the device may be impaired.

Note 2: A heat sink is required to keep the junction temperature below absolute maximum when the output is shorted.

Note 3: Exceeding the input common mode range may cause the output to invert.

Note 4: Slew rate is measured between $\pm 1\text{V}$ on the output, with a $\pm 0.3\text{V}$ input step.

Note 5: Full-power bandwidth is calculated from the slew rate measurement:

$$FPBW = SR/2\pi V_p.$$

Note 6: Settling time measurement techniques are shown in "Take the Guesswork Out of Settling Time Measurements," EDN, September 19, 1985. $A_V = -5$, $R_L = 1\text{k}$.

Note 7: NTSC (3.58MHz). For $R_L = 1\text{k}$, Diff $A_V = 0.1\%$, Diff Ph = 0.01° . Diff A_V and Diff Ph can be reduced for $A_V < 10$.

Note 8: See Applications section for shutdown at elevated temperatures. Do not operate the shutdown above $T_J > 125^{\circ}\text{C}$.

Note 9: AC parameters are 100% tested on the ceramic and plastic DIP packaged parts (J and N suffix) and are sample tested on every lot of the SO packaged parts (S suffix).

Optional Offset Nulling Circuit

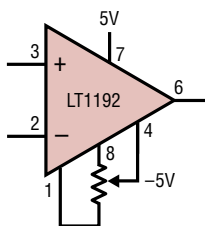

INPUT OFFSET VOLTAGE CAN BE ADJUSTED OVER A $\pm 20\text{mV}$ RANGE WITH A $1\text{k}\Omega$ TO $10\text{k}\Omega$ POTENTIOMETER

LT1192 • TA03

TYPICAL PERFORMANCE CHARACTERISTICS

Input Bias Current vs Common Mode Voltage

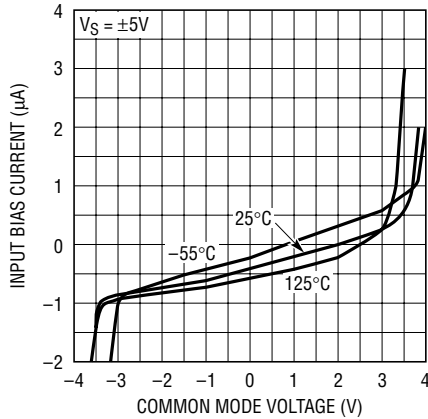

LT1192 • TPC01

Input Bias Current vs Temperature

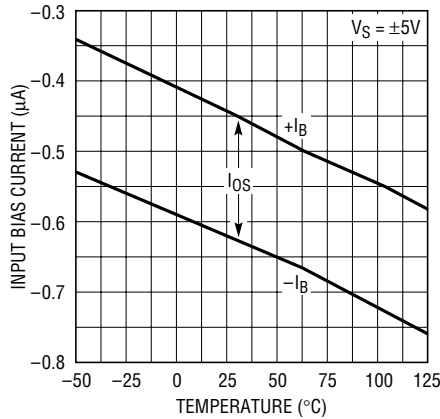

LT1192 • TPC02

Common Mode Voltage vs Supply Voltage

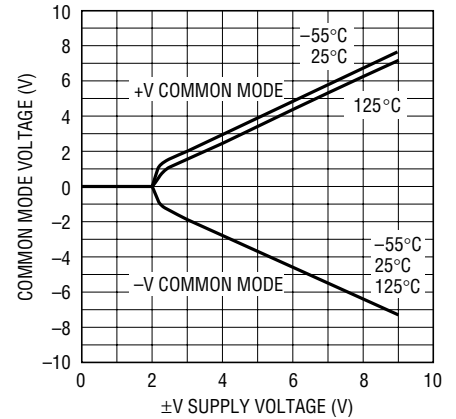

LT1192 • TPC03

Equivalent Input Noise Voltage vs Frequency

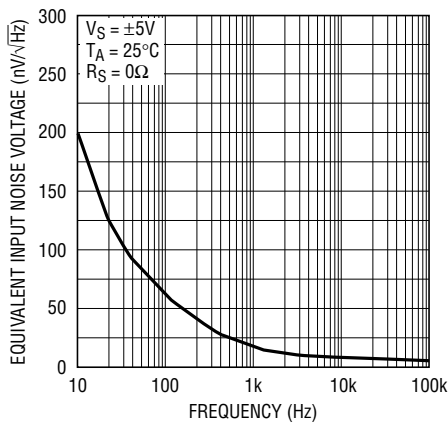

LT1192 • TPC04

Equivalent Input Noise Current vs Frequency

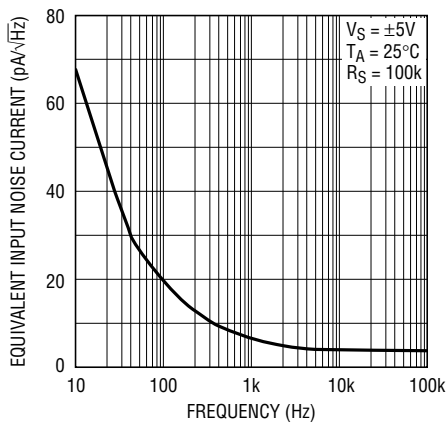

LT1192 • TPC05

Supply Current vs Supply Voltage

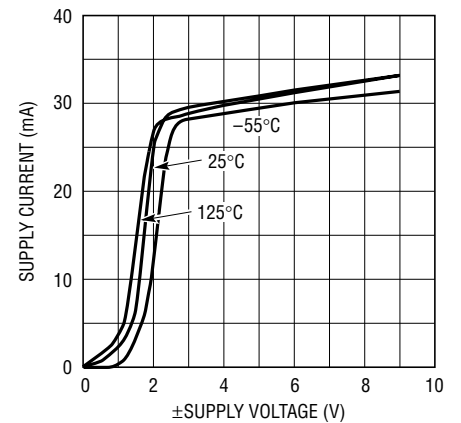

LT1192 • TPC06

Shutdown Supply Current vs Temperature

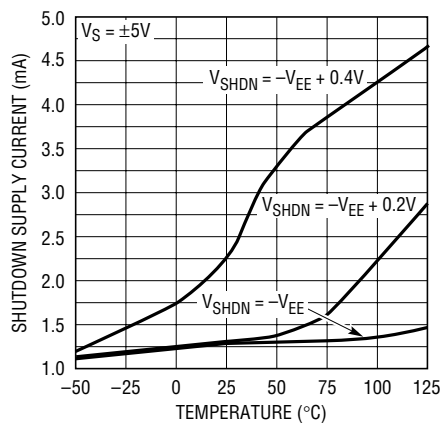

LT1192 • TPC07

Open-Loop Voltage Gain vs Temperature

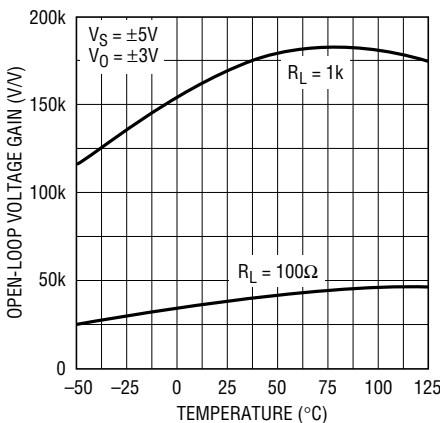

LT1192 • TPC08

Open-Loop Voltage Gain vs Load Resistance

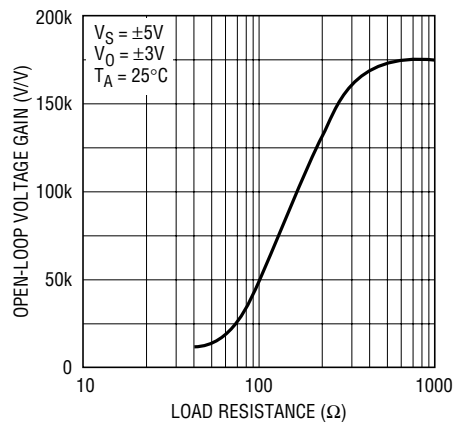

LT1192 • TPC09

TYPICAL PERFORMANCE CHARACTERISTICS

Gain, Phase vs Frequency

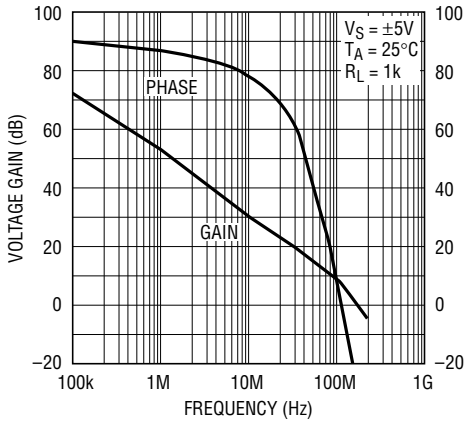

LT1192 • TPC10

Gain Bandwidth Product vs Supply Voltage

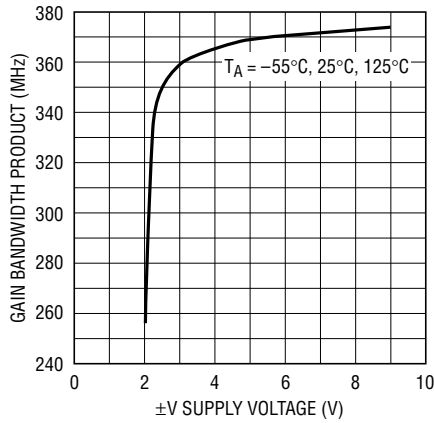

LT1192 • TPC11

Output Impedance vs Frequency

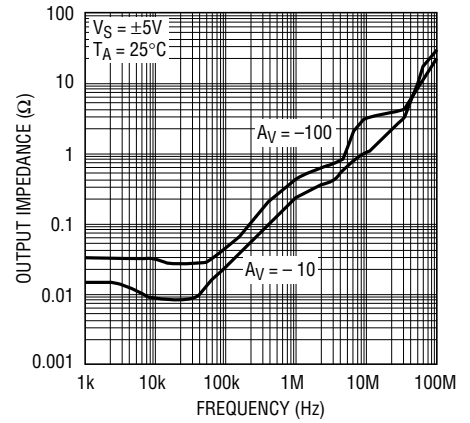

LT1192 • TPC13

Gain and Phase Margin vs Temperature

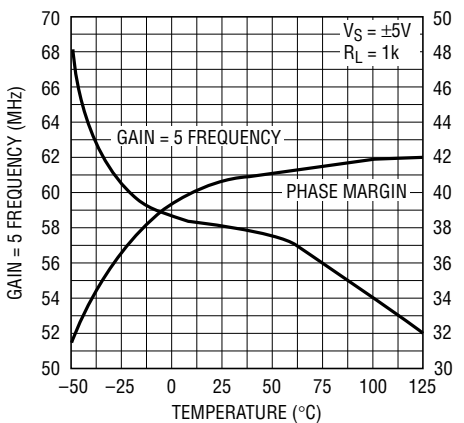

LT1192 • TPC12

Common Mode Rejection Ratio vs Frequency

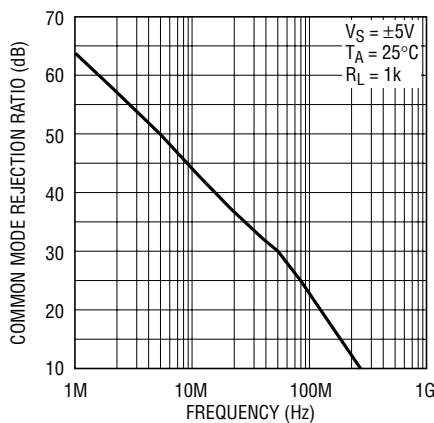

LT1192 • TPC14

Power Supply Rejection Ratio vs Frequency

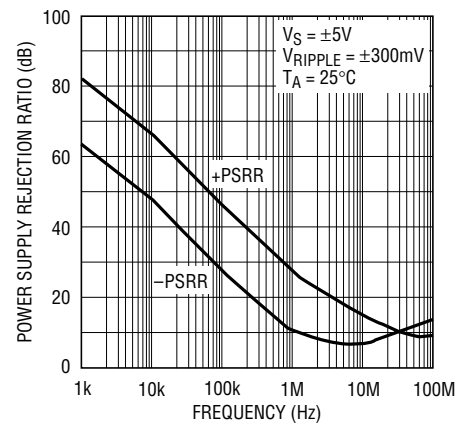

LT1192 • TPC15

Output Short-Circuit Current vs Temperature

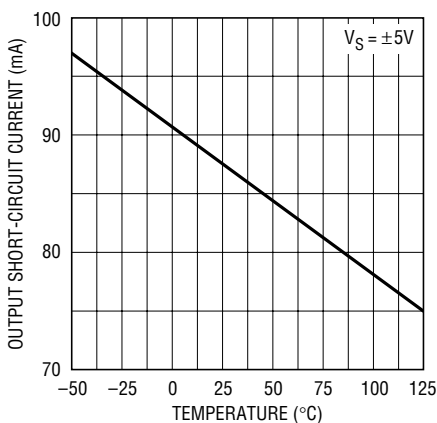

LT1192 • TPC16

Output Swing vs Supply Voltage

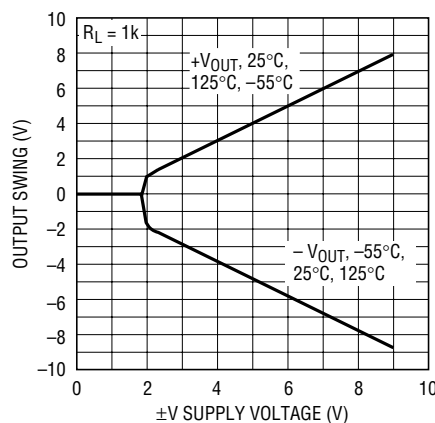

LT1192 • TPC17

Output Voltage Swing vs Load Resistance

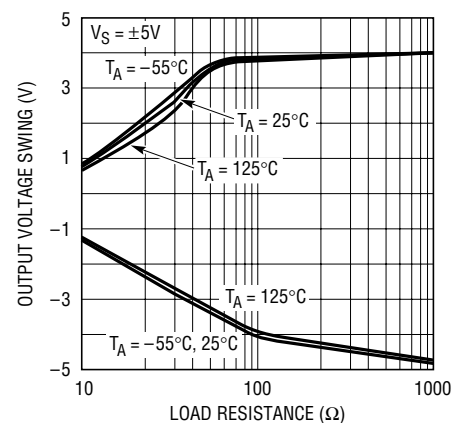

LT1192 • TPC18

TYPICAL PERFORMANCE CHARACTERISTICS

Slew Rate vs Temperature

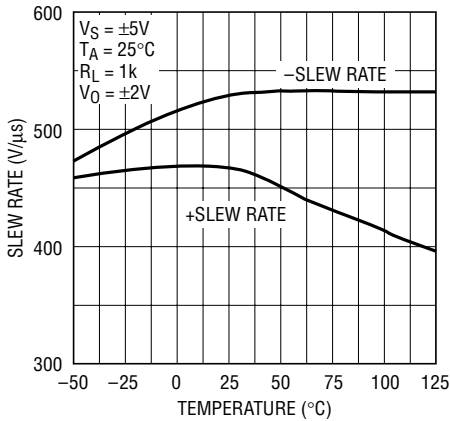

LT1192 • TPC19

Output Voltage Step vs Settling Time, $A_V = -5$

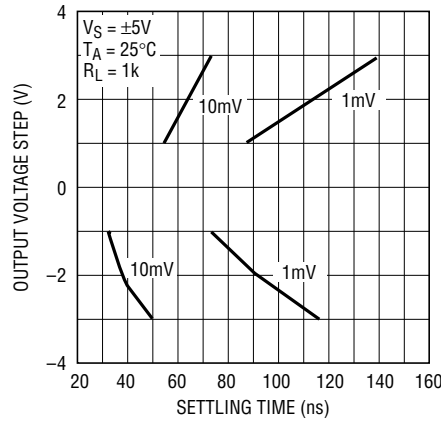

LT1192 • TPC20

Output Voltage Step vs Settling Time, $A_V = 5$

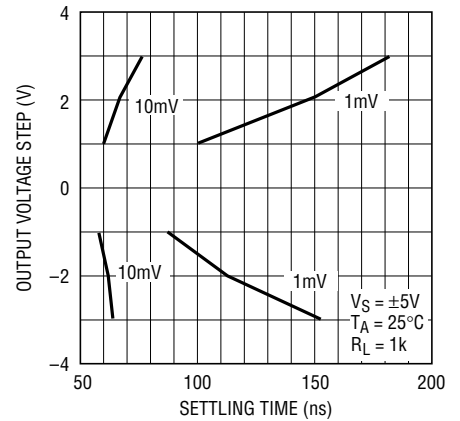

LT1192 • TPC21

Large-Signal Transient Response

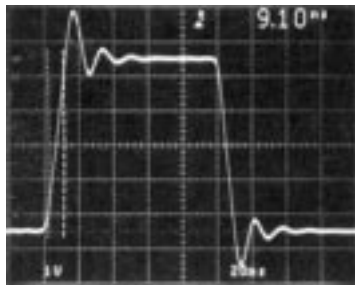

LT1192 • TPC22

$A_V = 5$, $C_L = 10\text{pF}$ SCOPE PROBE

Small-Signal Transient Response

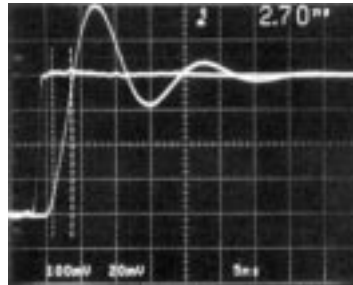

LT1192 • TPC23

$A_V = 5$, SMALL-SIGNAL RISE TIME, WITH FET PROBES

Output Overload

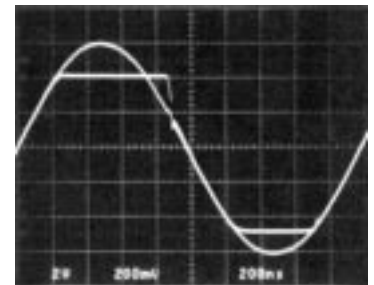

LT1192 • TPC24

$A_V = 10$, $V_{IN} = 1.2\text{V}_{P-P}$

APPLICATIONS INFORMATION

Power Supply Bypassing

The LT1192 is quite tolerant of power supply bypassing. In some applications a $0.1\mu\text{F}$ ceramic disc capacitor placed 1/2 inch from the amplifier is all that is required. A scope photo of the amplifier output with no supply bypassing is used to demonstrate this bypassing tolerance, $R_L = 1\text{k}$.

In most applications, and those requiring good settling time, it is important to use multiple bypass capacitors. A $0.1\mu\text{F}$ ceramic disc in parallel with a $4.7\mu\text{F}$ tantalum is recommended. Two oscilloscope photos with different bypass conditions are used to illustrate the settling time characteristics of the amplifier. Note that although the output waveform looks acceptable at $1\text{V}/\text{DIV}$, when

No Supply Bypass Capacitors

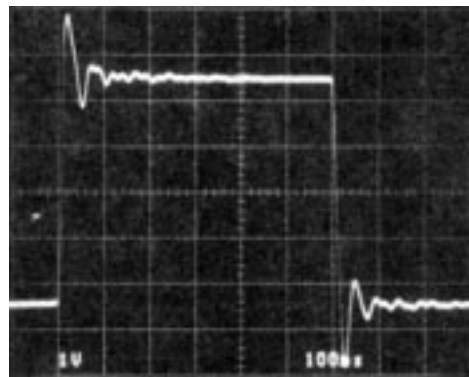

LT1192 • TA04

$A_V = -5$, IN DEMO BOARD, $R_L = 1\text{k}$

APPLICATIONS INFORMATION

amplified to 1mV/DIV the settling time to 1mV is 4.132 μ s for the 0.1 μ F bypass; the time drops to 140ns with multiple bypass capacitors.

Settling Time Poor Bypass

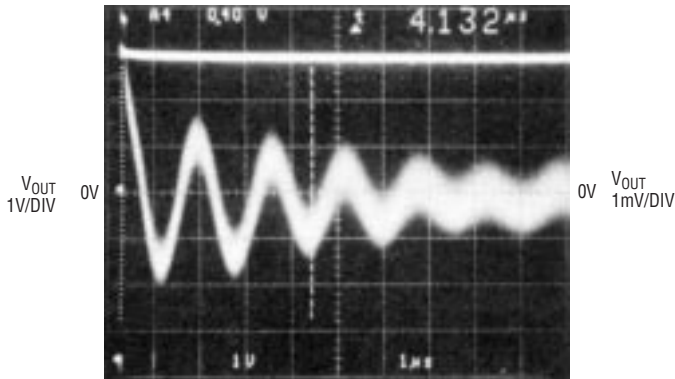

SETTLING TIME TO 1mV, $A_V = -1$
SUPPLY BYPASS CAPACITORS = 0.1 μ F

Settling Time Good Bypass

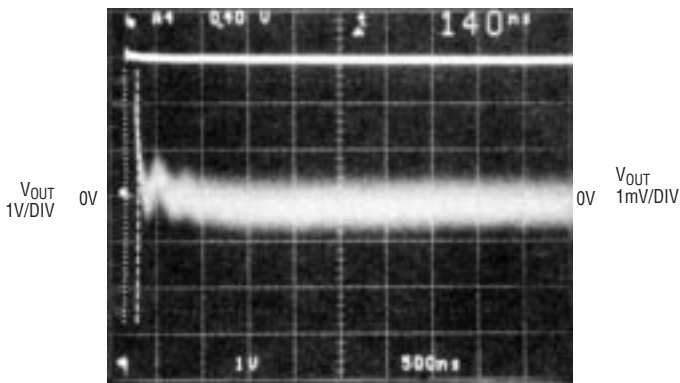

SETTLING TIME TO 1mV, $A_V = -1$
SUPPLY BYPASS CAPACITORS = 0.1 μ F + 4.7 μ F TANTALUM

Cable Terminations

The LT1192 operational amplifier has been optimized as a low cost video cable driver. The ± 50 mA guaranteed output current enables the LT1192 to easily deliver 7.5V_{P-P} into 100 Ω , while operating on ± 5 V supplies or 2.6V_{P-P} on a single 5V supply.

When driving a cable it is important to terminate the cable to avoid unwanted reflections. This can be done in one of two ways: single termination or double termination. With single termination, the cable must be terminated at the receiving end (75 Ω to ground) to absorb unwanted

Double Terminated Cable Driver

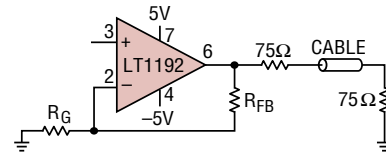

Cable Driver Voltage Gain vs Frequency

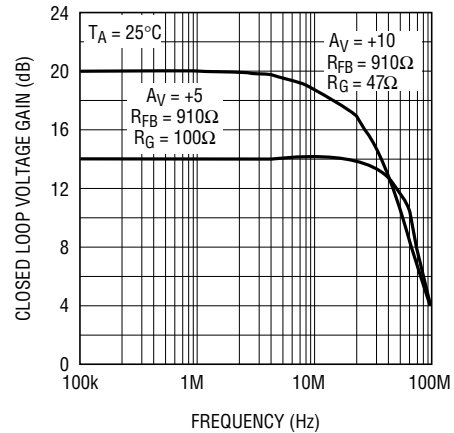

energy. The best performance can be obtained by double termination (75 Ω in series with the output of the amplifier, and 75 Ω to ground at the other end of the cable). This termination is preferred because reflected energy is absorbed at each end of the cable. When using the double termination technique it is important to note that the signal is attenuated by a factor of 2, or 6dB. For a cable driver with a gain of 5 (op amp gain of 10) the -3 dB bandwidth is 56MHz with only 0.25dB of peaking.

Using the Shutdown Feature

The LT1192 has a unique feature that allows the amplifier to be shut down for conserving power or for multiplexing several amplifiers onto a common cable. The amplifier will shut down by taking Pin 5 to V^- . In shutdown, the amplifier dissipates 15mW while maintaining a true high impedance output state of 15k Ω in parallel with the feedback resistors. The amplifiers must be used in a noninverting configuration for MUX applications. In inverting configurations the input signal is fed to the output through the feedback components. When the output is loaded with as little as 1k Ω from the amplifier's feedback resistors, the amplifier shuts off in 400ns. This shutoff can be under the control of HC CMOS operating between 0V and -5 V.

APPLICATIONS INFORMATION

Output Shutdown

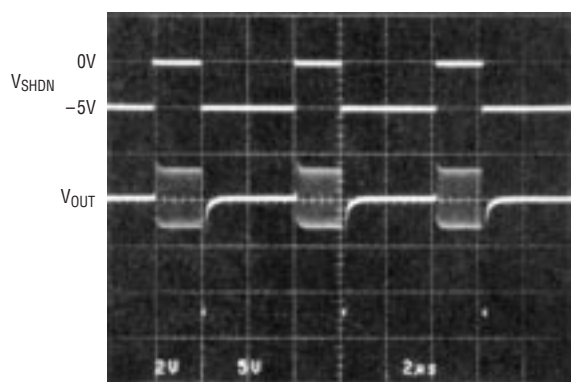

1MHz SINE WAVE GATED OFF WITH SHUTDOWN PIN, $A_V = 10$, $R_L = 1k$

LT1192 • TA08

Small-Signal Transient Response

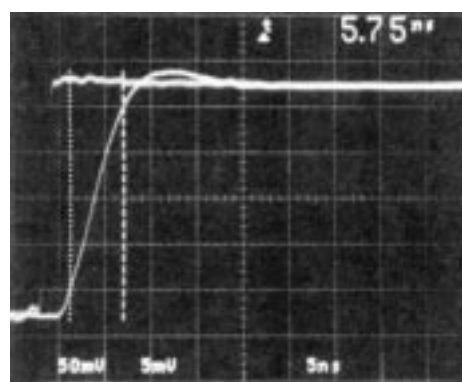

$A_V = 10$, SMALL-SIGNAL RISE TIME, WITH FET PROBES

LT1192 • TA09

The ability to maintain shutoff is shown on the curve Shutdown Supply Current vs Temperature in the Typical Performance Characteristics section. At very high elevated temperatures it is important to hold the SHDN pin close to the negative supply to keep the supply current from increasing.

Operating with Low Closed-Loop Gains

When using uncompensated amplifiers it should be realized that peaking in the frequency domain, and overshoot and ringing in the time domain occur as closed-loop gain is lowered. The LT1192 is stable to a closed-loop gain of 5, however, peaking and ringing can be minimized by increasing the closed-loop gain. For instance, the LT1192 peaks 5dB when used in a gain of 5, but peaks by less than 0.5dB for a closed-loop gain of 10. Likewise, the overshoot drops from 50% to 4% for gains of 10.

Murphy Circuits

There are several precautions the user should take when using the LT1192 in order to realize its full capability. Although the LT1192 can drive a 50pF load, isolating the capacitance with 20Ω can be helpful. Precautions primarily have to do with driving large capacitive loads.

Closed-Loop Voltage Gain vs Frequency

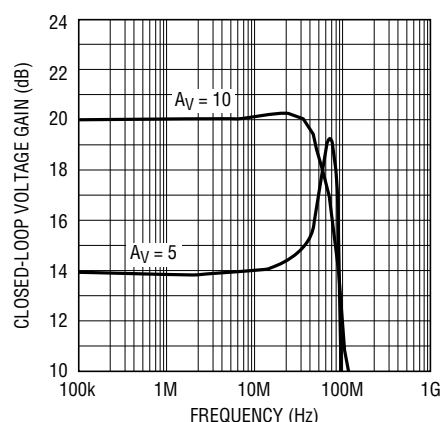

LT1192 • TA10

Other precautions include:

1. Use a ground plane (see Design Note 50, High Frequency Amplifier Evaluation Board).
2. Do not use high source impedances. The input capacitance of 2pF, and $R_S = 10k$ for instance, will give an 8MHz –3dB bandwidth.
3. PC board socket may reduce stability.
4. A feedback resistor of 1k or lower reduces the effects of stray capacitance at the inverting input.

APPLICATIONS INFORMATION

Driving Capacitive Load

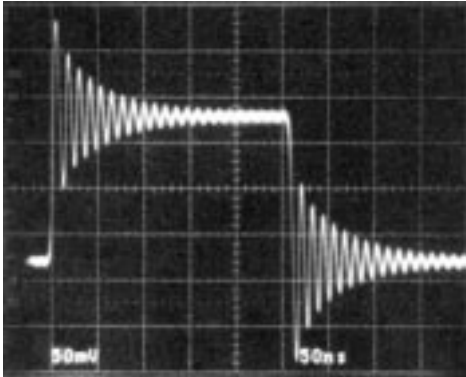

$A_V = -5$, IN DEMO BOARD, $C_L = 50\text{pF}$

LT1192 • TA11

Driving Capacitive Load

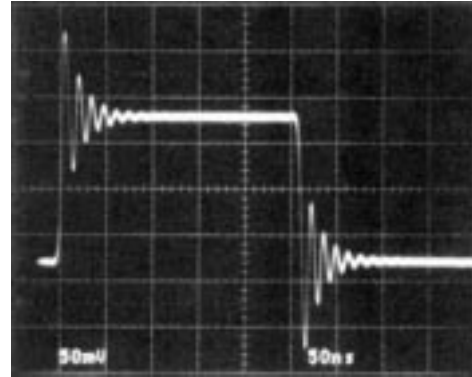

$A_V = -5$, IN DEMO BOARD, $C_L = 50\text{pF}$
WITH 20Ω ISOLATING RESISTOR

LT1192 • TA12

Murphy Circuits

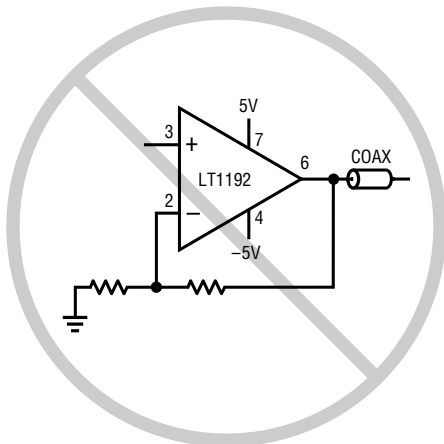

An unterminated cable is a large capacitive load

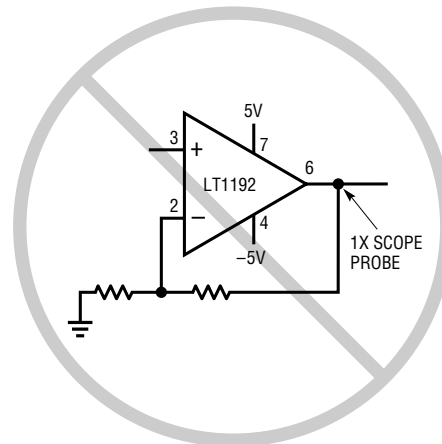

A 1X Scope Probe is a large capacitive load

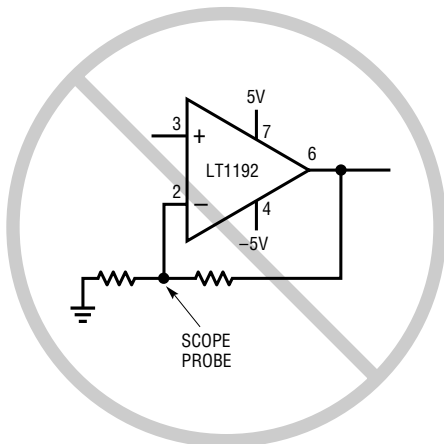

A Scope Probe on the Inverting Input Reduces Phase Margin

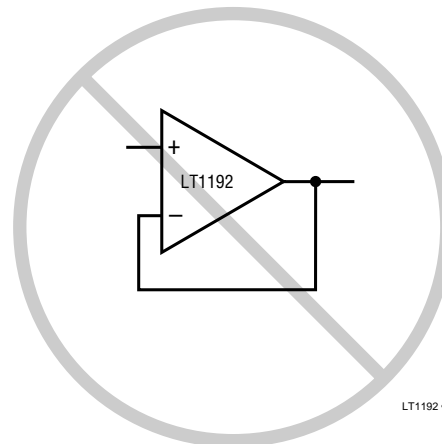

LT1192 • TA13

LT1192 is Stable for Gains $\geq 5\text{V/V}$

SIMPLIFIED SCHEMATIC

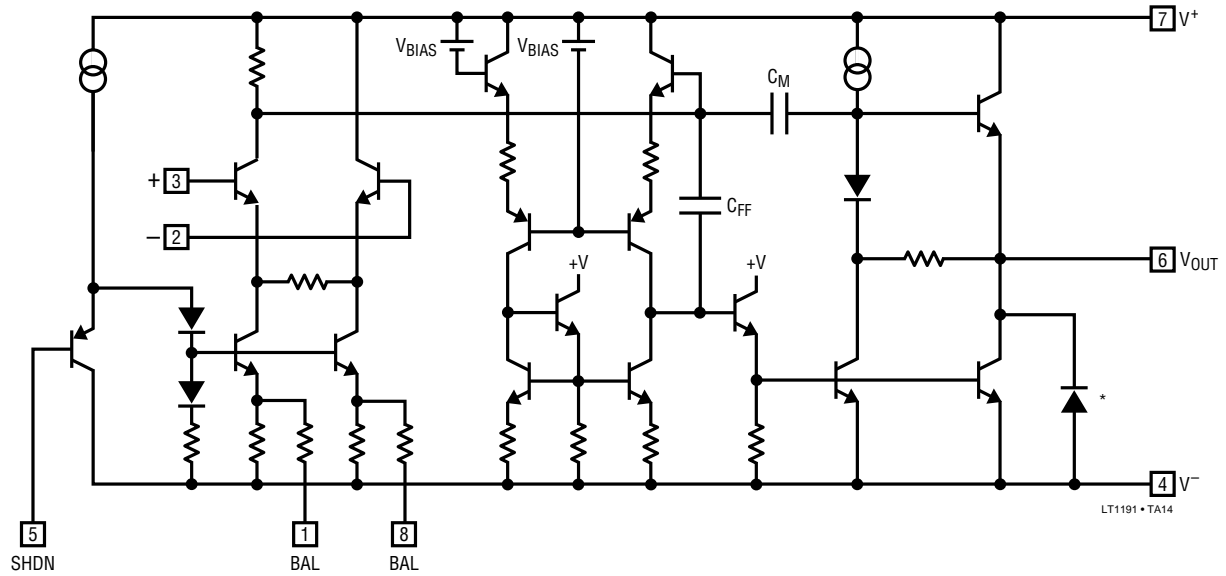

*SUBSTRATE DIODE, DO NOT FORWARD BIAS

PACKAGE DESCRIPTION

J8 Package 8-Lead Cerdip (Narrow .300 Inch, Hermetic) (Reference LTC DWG # 05-08-1110)

CORNER LEADS OPTION
(4 PLCS)

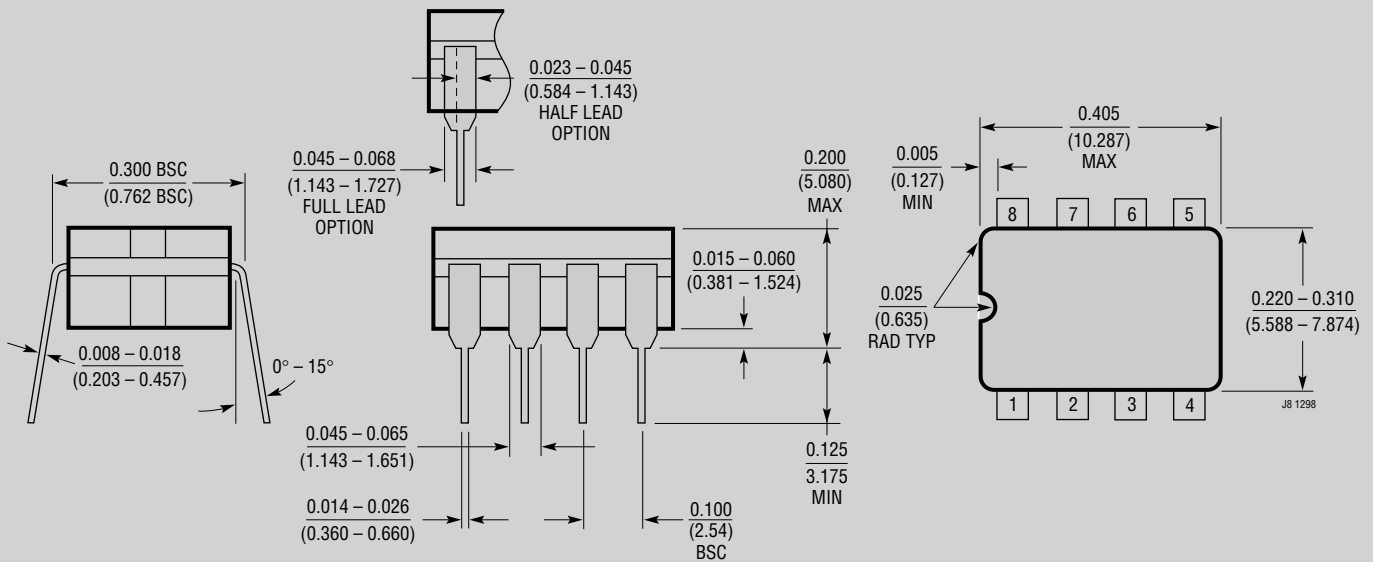

NOTE: LEAD DIMENSIONS APPLY TO SOLDER DIP/PLATE OR TIN PLATE LEADS

OBSOLETE PACKAGE

PACKAGE DESCRIPTION

N8 Package
8-Lead PDIP (Narrow .300 Inch)
 (Reference LTC DWG # 05-08-1510)

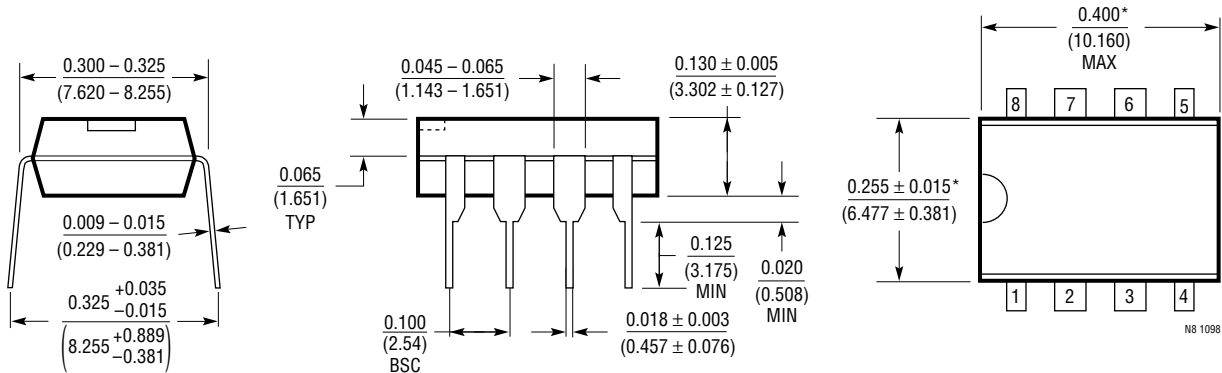

*THESE DIMENSIONS DO NOT INCLUDE MOLD FLASH OR PROTRUSIONS.
 MOLD FLASH OR PROTRUSIONS SHALL NOT EXCEED 0.010 INCH (0.254mm)

S8 Package
8-Lead Plastic Small Outline (Narrow .150 Inch)
 (Reference LTC DWG # 05-08-1610)

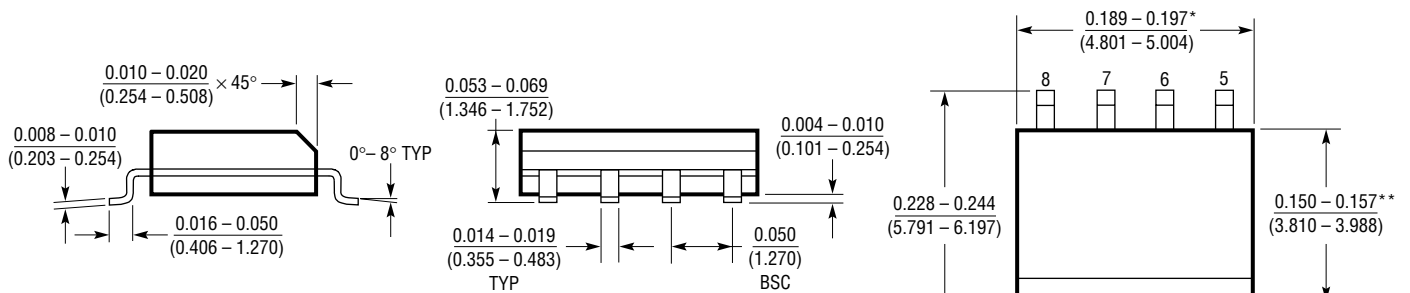

*DIMENSION DOES NOT INCLUDE MOLD FLASH. MOLD FLASH SHALL NOT EXCEED 0.006" (0.152mm) PER SIDE
 **DIMENSION DOES NOT INCLUDE INTERLEAD FLASH. INTERLEAD FLASH SHALL NOT EXCEED 0.010" (0.254mm) PER SIDE

RELATED PARTS

PART NUMBER	DESCRIPTION	COMMENTS
LT1221	High Speed Operational Amplifier	150MHz Gain Bandwidth, 200V/ μ s Slew Rate, $e_n = 6nV/\sqrt{Hz}$
LT1222	High Speed Operational Amplifier	500MHz Gain Bandwidth, 200V/ μ s Slew Rate, $e_n = 3nV/\sqrt{Hz}$
LT1225	High Speed Operational Amplifier	150MHz Gain Bandwidth, 400V/ μ s Slew Rate, $I_S = 7mA$